

KKK series Nozzle with Variable Spray Angle and Spray Capacity

Iron making process ● Cooling slag

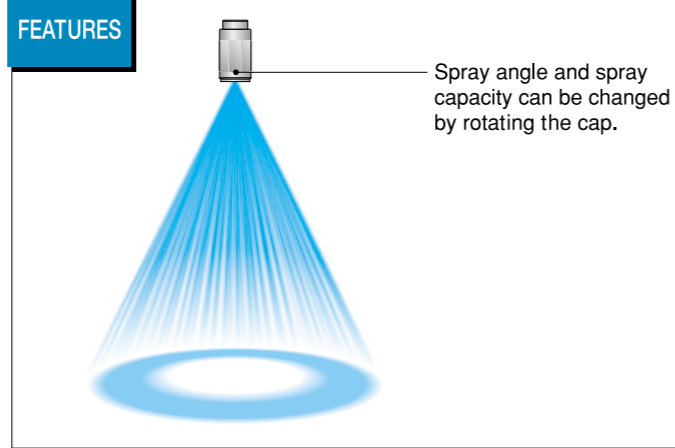
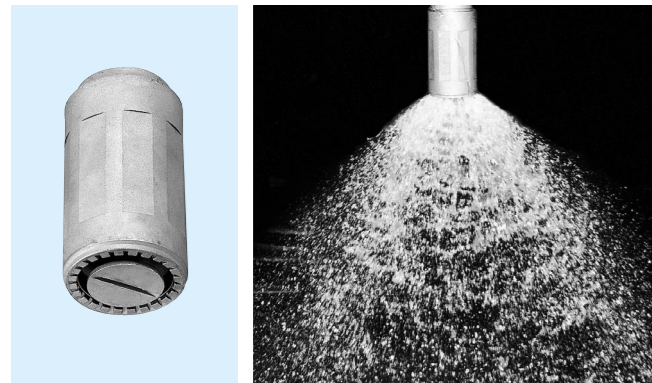

KKK nozzles used in slag cooling

Slag can be effectively cooled by changing the cooling zone; the cooling zone can be changed by changing spray angle and spray capacity.

Slag pit

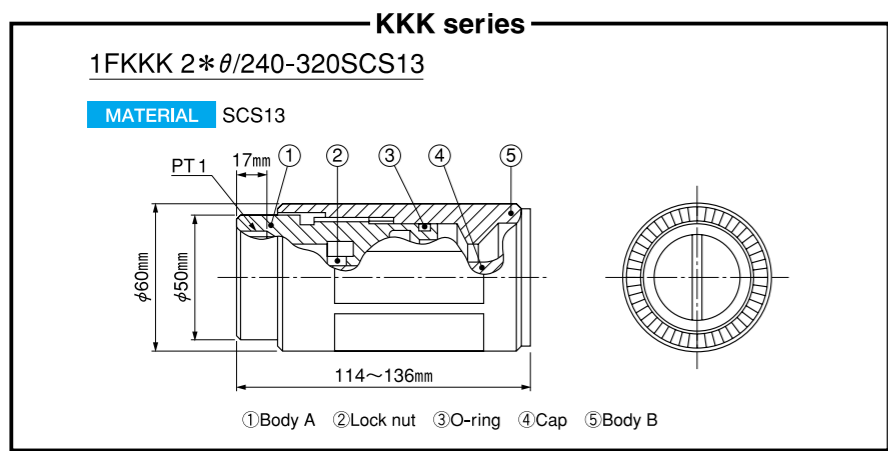
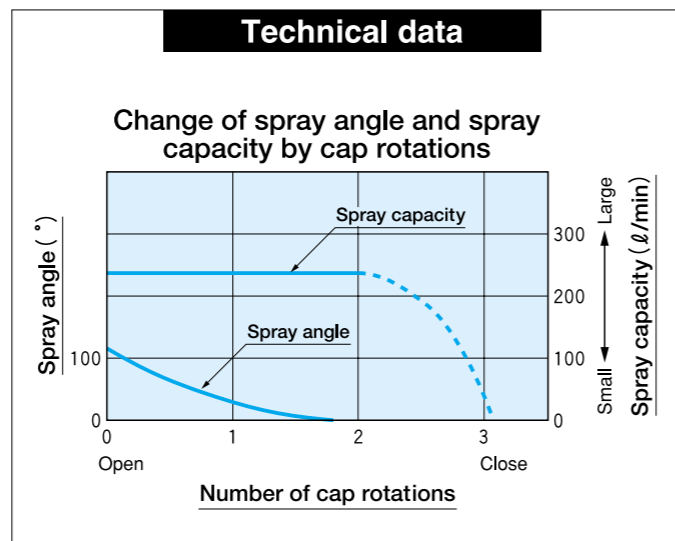

● Available KKK series

Series	Pipe connection size	Pressure: 0.2MPa	
		Spray angle	Spray capacity (ℓ/min)
1FKKK 2*θ/240-320SCS13	1F	105°	240~320
1¼FKKK 2*θ/300-400SCS13	1¼F	105°	300~400

Conversion of unit [Pressure] 0.1MPa ≒ 14.50psi [Flow rate] 1ℓ (liter) ≒ 0.264 US gal.
10psi ≒ 0.069MPa 1US gal. ≒ 3.79ℓ (liter)



How to order

Please inquire or order for a specific nozzle using this coding system.

1FKKK 2*θ/240-320SCS13 or 1¼FKKK 2*θ/300-400SCS13

LLYOH series Blower LYOHM header

Surface finish ● Cooling for each steel plate process; CGL,CAPL,EGL,CCL

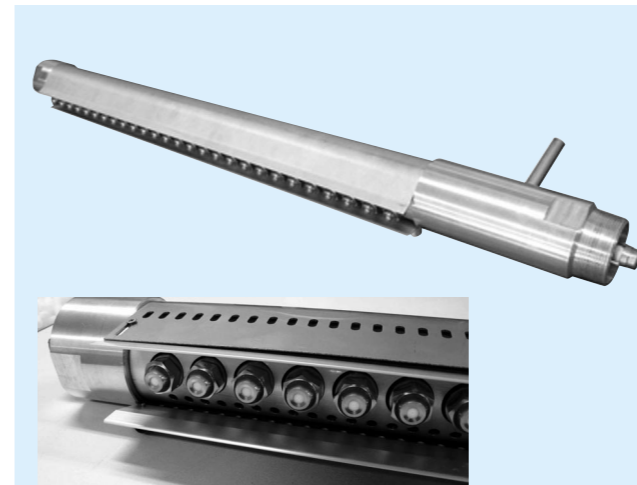

*LYOHM nozzle which can spray Semi Dry Fog® (droplet size 10-30μm)

● Spray capacity and Blower air consumption

Liquid pressure (MPa)	Spray capacity (ℓ/min)	Blower air pressure (kPa)	Blower air consumption (m³/min)
6	28.3	0	0
		1	2.4
		3	4.46
		5	5.72
		7	6.69

* Performance data of Blower LYOHM header with 27pcs. of LYOHM nozzles, spray length 700mm.

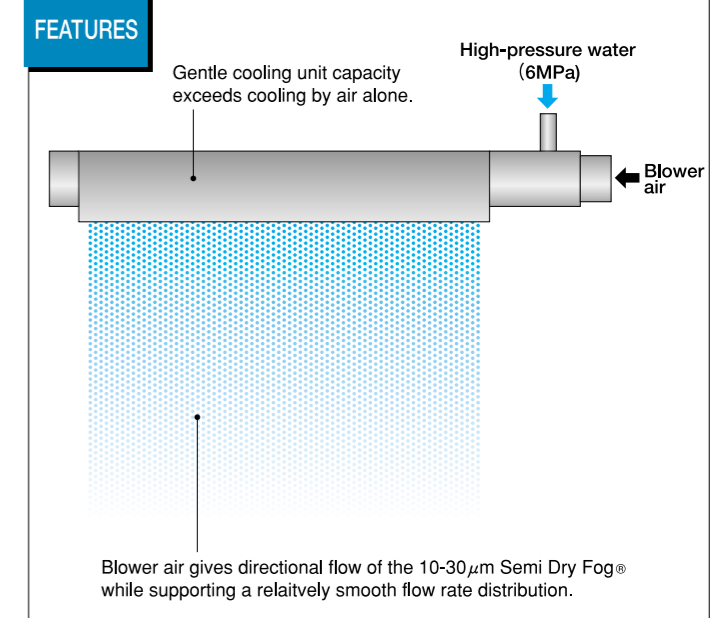

● Relationship between blower pressure and droplet speed

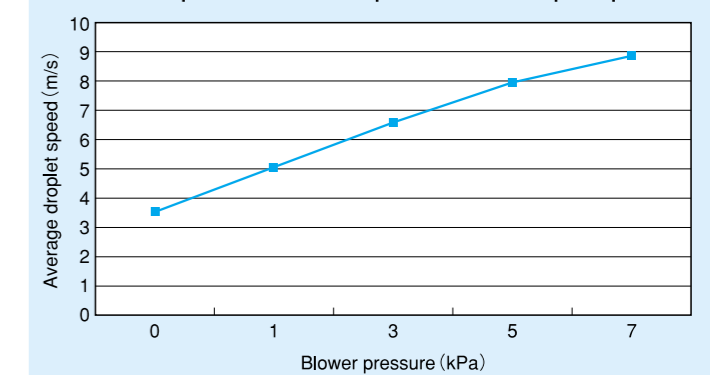

* At distances under 150mm, droplet speed is roughly proportional to blower pressure.

How to order

Please contact our local sales for details.

TAIFUJet® series Air Nozzles

Patented

Various process

- Air cooling
- Blow-off drying
- Stripping
- Cleaning
- Blowing off dust
- Air blow transport

FEATURES

Flat type

Noise level reduced by 10dB compared to conventional one-hole air nozzle with the same air volume

TAIFUJet®

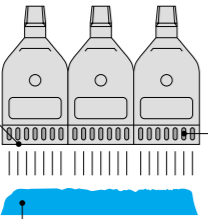

Uniform distribution resulting from the unique design.

Conventional nozzles

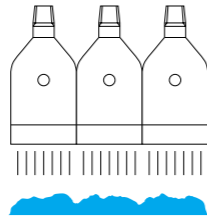

Unique design of TAIFUJet® takes in surrounding air and amplifies air flow.

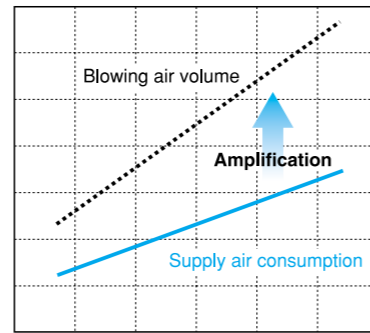

Long flat type

Space-saving design



Long flat type designed for blowing air over greater widths. Width type, 100mm-1400mm, are available.

Round type

Noise level reduced by more than 10dB compared to conventional one-hole air nozzle with the same air volume.

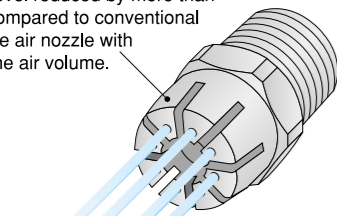

High impact solid pinpoint stream of blown air.

Noise level comparison

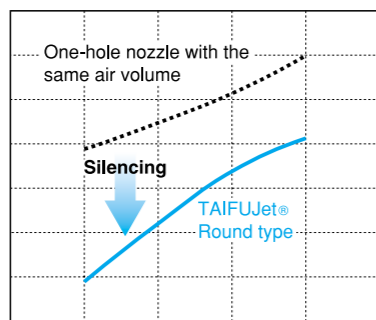

Round multiple header type

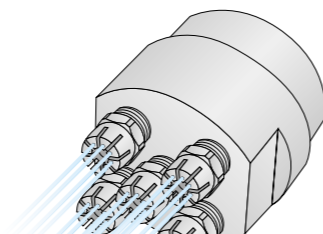

Powerful air blow.

Examples of TAIFUJet® applications

Blow off dust of steel plates

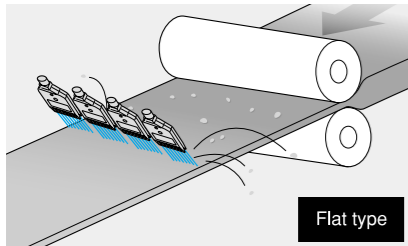

Flat type

Edge wiper for steel surface treatment (blow-off drying)

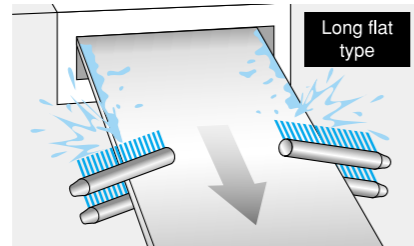

Long flat type

Blow-off drying for shaped steel

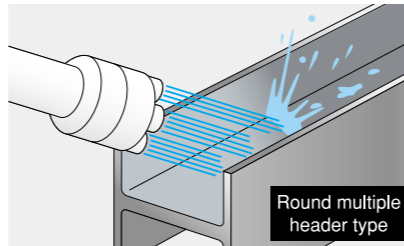

Round multiple header type

TAIFUJet® series Air Nozzles

TAIFUJet® Lineup

	PLASTIC	METAL
FOR COMPRESSORS	FLAT TYPE Affordable standard air nozzle (42mm wide) <ul style="list-style-type: none"> ● Orifice diameter φ1.0mm ● Width 42mm ● Material PPS ● Pipe connection size 1/4M 	Ultra-compact air nozzle (24mm wide, 30mm long) <ul style="list-style-type: none"> ● Orifice diameter φ1.0mm ● Width 24mm ● Material PPS ● Pipe connection size 1/8M
	Standard stainless air nozzle (42mm wide) <ul style="list-style-type: none"> ● Orifice diameter φ0.8~φ1.2mm ● Width 42mm ● Material Stainless steel ● Pipe connection size 1/4M 	Compact body with larger free passage diameter and wider spray <ul style="list-style-type: none"> ● Orifice diameter φ1.2mm ● Width 50mm ● Material Stainless steel ● Pipe connection size 1/4M
FOR BLOWERS	FLAT TYPE Standard air nozzle (42mm wide) <ul style="list-style-type: none"> ● Orifice diameter φ3.0mm ● Width 42mm ● Material ABS ● Pipe connection size 1/2M 	Air nozzle made of aluminum (42mm wide) <ul style="list-style-type: none"> ● Orifice diameter φ3.0mm ● Width 42mm ● Material Aluminum ● Pipe connection size 1/2M
	Long flat type space-saving design, made of plastic <ul style="list-style-type: none"> ● Orifice diameter φ3.0mm ● Length Please specify ● Material HTPVC 	Aluminum long flat type space-saving design <ul style="list-style-type: none"> ● Orifice diameter φ3.0mm ● Length Please specify ● Material Aluminum
FOR COMPRESSORS	ROUND TYPE Affordable air nozzle with high-impact, solid pinpoint stream of blown air <ul style="list-style-type: none"> ● Orifice diameter φ1.0mm ● Material PP 	Stainless air nozzle with high-impact solid pinpoint stream of blown air <ul style="list-style-type: none"> ● Orifice diameter φ0.8~φ1.6mm ● Material Stainless steel ● Pipe connection size 1/8M, 1/4M
	Multiple header type for applications needing stronger spray Header with 5pcs. of round-type stainless steel air nozzle Multiple header with 7pcs. of nozzles mounted on each header	
FOR BLOWERS	ROUND TYPE High-impact solid pinpoint stream of air blown <ul style="list-style-type: none"> ● Orifice diameter φ3.0mm ● Material ABS 	Aluminum air nozzle to spray a concentrated stream of blower air <ul style="list-style-type: none"> ● Orifice diameter φ3.0mm ● Material Aluminum

For details, please refer to our catalog of TAIFUJet® air nozzles.



SLNHB series Slit Nozzle Utilizing Blower Air

- Rolling Mills**
- Blow-off drying
 - Blowing off dust
 - Cooling

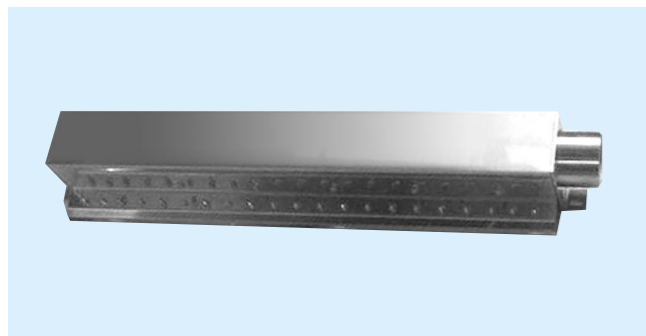

FEATURES

- Uniform spray distribution
- Blowing large air volume
- Air consumption (running cost) is saved due to utilization of conventional blowers.

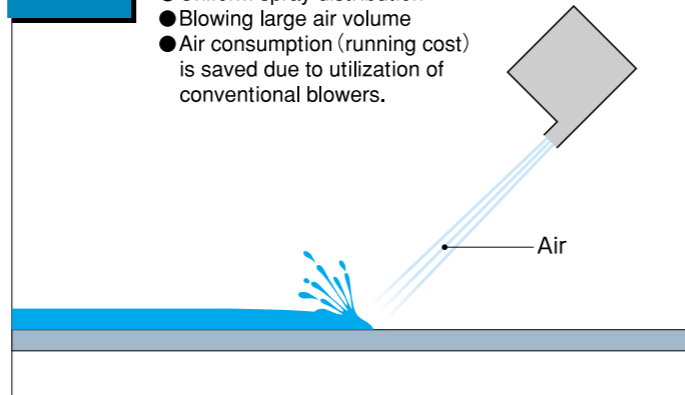

SLNHB eliminates gaps in air blowing!

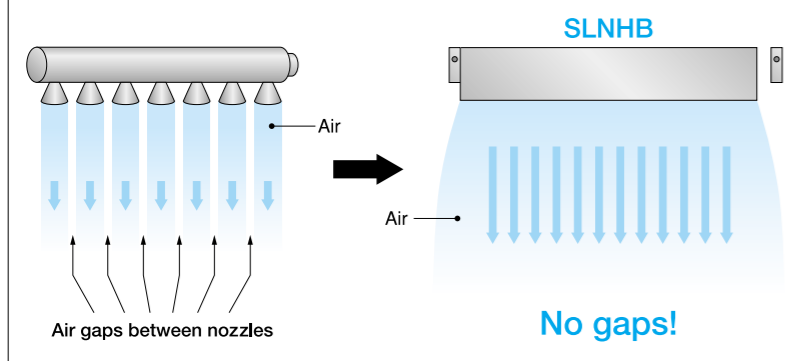

Specifications

- **Materials:** Main parts S304 Packing PE
- **Slit size:** Slit opening 0.5~2.0mm Slit length 600~1200mm
- **Air inlet size:** 2" PT Male for pipe connection ($\phi 65, \phi 75, \phi 100$ for hose connection)
- **Pressure:** 5~30kPa
- **Blowing air volume:** 1.83~11.0Nm³/min (at 10kPa)

Special Slit Nozzles



Water (Air) curtain slit nozzles
Slit-lamner SLNH(A)-H series



Pneumatic slit nozzles
PSN series

*Please also refer to the information of P.30.

How to order

For details of this product, please refer to a special leaflet and catalog.

UT series Universal Ball Joints

Metal UT



*UT ball joint with spray nozzle

FEATURES

- Accurate nozzle alignment is possible after connecting to pipe.
- Adjust spray direction as desired over a range of 50°.

Cautions

Maximum pressure:
15MPa for UT-S303
4MPa for UT-Brass (C3604)
*Do not use under conditions where water hammer or sudden change in water pressure may occur.

Plastic UT



*UT ball joint with spray nozzle

FEATURES

- Adjustable spray direction while spraying up to 0.3MPa.
- No O-ring. Easy installation by hand without tools.
- Lightweight, half that of metal UT ball joints.
- Low price due to injection molding.

Cautions

Maximum pressure is 1MPa (at room temperature).
*Do not use under conditions where water hammer or sudden change in water pressure may occur.

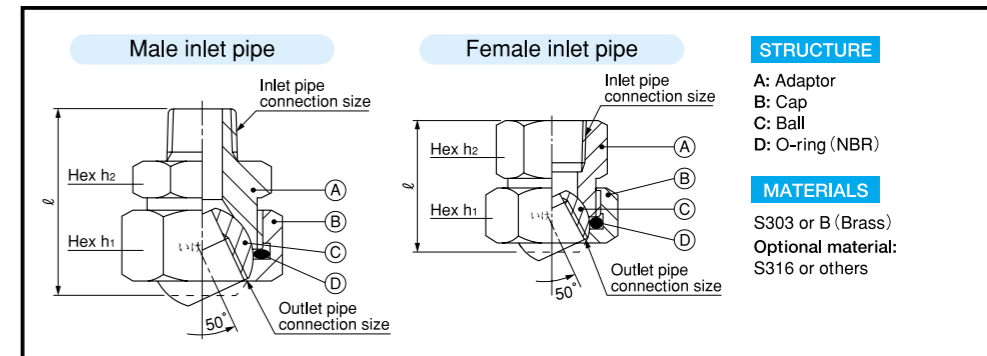

STRUCTURE

- A: Adaptor
- B: Cap
- C: Ball
- D: O-ring (NBR)

MATERIALS

S303 or B (Brass)
Optional material:
S316 or others

Series model (Inlet x Outlet)	Inlet pipe connection size	Outlet pipe connection size	Dimensions (mm)			Mass (g)	
			ℓ	h ₁	h ₂	B	S303
UT1/8M x 1/8F☆	1/8M	1/8F	32.5	22	21	60	56
UT1/4M x 1/8F☆	1/4M	1/8F	36.0	22	21	65	60
UT1/4M x 1/4F☆	1/4M	1/4F	39.5	29	24	110	100
UT3/8M x 1/4F☆	3/8M	1/4F	40.0	29	24	115	110
UT3/8M x 3/8F☆	3/8M	3/8F	47.5	35	30	205	190
UT1/8F x 1/8F☆	1/8F	1/8F	28.5	22	21	69	63
UT1/4F x 1/8F☆	1/4F	1/8F	28.5	22	21	63	58
UT1/4F x 1/4F☆	1/4F	1/4F	33.5	29	24	120	110
UT3/8F x 1/4F☆	3/8F	1/4F	33.5	29	24	110	100
UT3/8F x 3/8F☆	3/8F	3/8F	44.5	35	30	235	220

☆=Material code Set to "B" for brass or "S303" for stainless steel 303 (see "How to order" below)

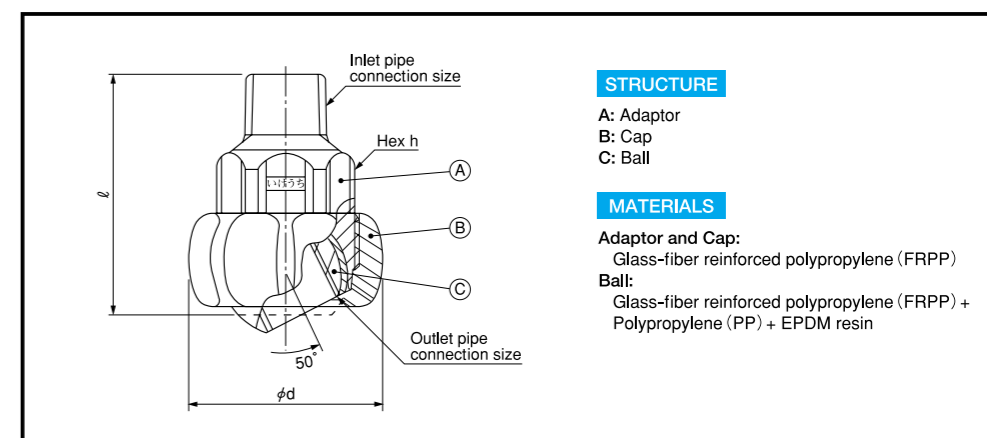

STRUCTURE

- A: Adaptor
- B: Cap
- C: Ball

MATERIALS

Adaptor and Cap:
Glass-fiber reinforced polypropylene (FRPP)
Ball:
Glass-fiber reinforced polypropylene (FRPP) + Polypropylene (PP) + EPDM resin

Series model (Inlet x Outlet)	Inlet pipe connection size	Outlet pipe connection size	Dimensions (mm)			Mass (g)
			ℓ	ϕd	h	FRPP
UT1/8M x 1/8F	1/8M	1/8F	38.0	32	21	15
UT1/4M x 1/8F	1/4M	1/8F	40.0	32	21	16
UT1/4M x 1/4F	1/4M	1/4F	40.0	32	21	15
UT3/8M x 1/8F	3/8M	1/8F	41.0	32	21	16
UT3/8M x 1/4F	3/8M	1/4F	41.0	32	21	15

How to order

Please inquire or order for a specific ball joint using this coding system.

〈Example〉 UT 1/8M x 1/8F S303

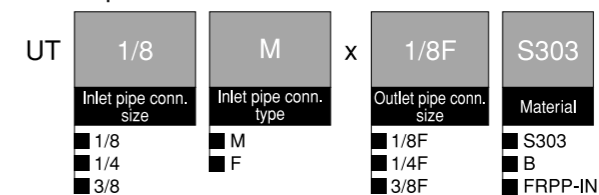

KIT series High-pressure Tank Cleaning Nozzles

Rolling mill process ● Cleaning various types of tanks



FEATURES Rotates by water pressure (oil-free).

Unique gear mechanism completely cleans inside of tank.

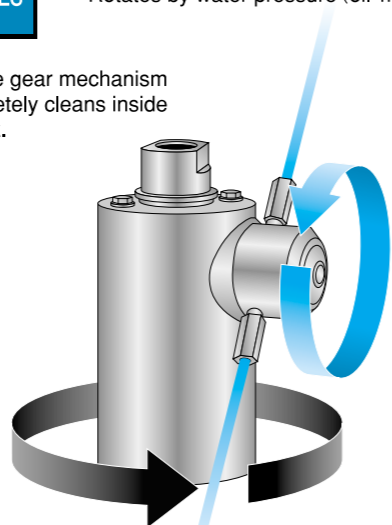

CERJet, ceramic tip inserted nozzle, provides excellent wear life at high pressure use.

KIT series used in tank cleaning

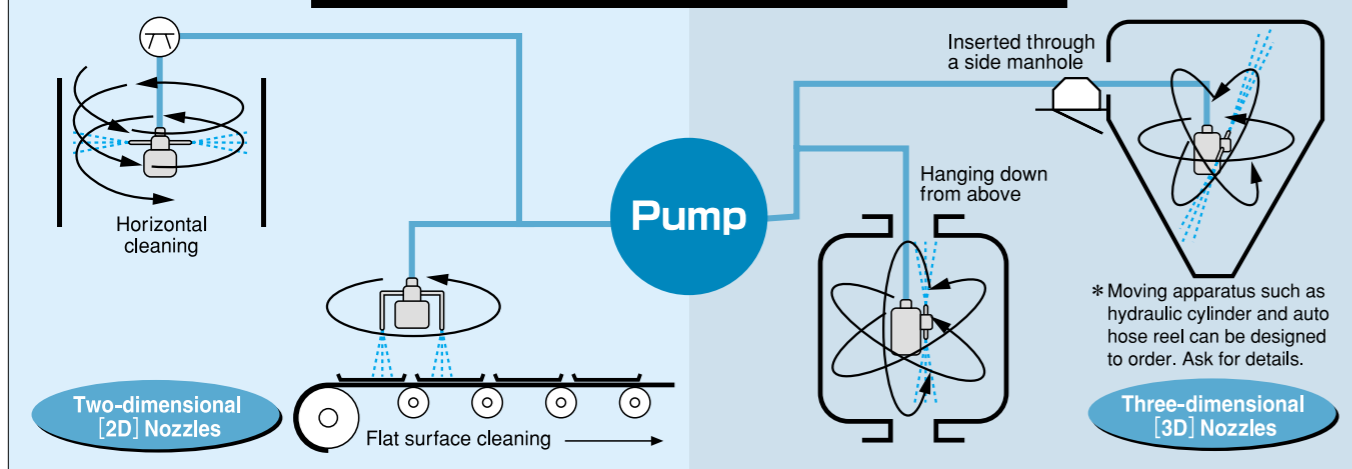

Specifications

● 3D Nozzles *For additional specifications and information, contact our local sales.

Type	TD-301	TD-311	TDH-311	HS-30	HS-32	HS-33	HS-35	THS-33
Liquid pressure range (MPa)	0.2-8.0	0.2-8.0	4.0-20.0	0.5-2.0	4.0-20.0	4.0-35.0	35.0-50.0	5.0-35.0
Maximum use temperature (deg C)	80	80	120	120	120	120	120	120
Maximum spray capacity (ℓ/min)	150	300	700	60	150	300	300	300
Pipe connection size	PT3/4"	PT1"	PT1"	PT3/4"	PT1/2"	PT3/4"	PT3/4"	PT3/4"
Dimensions (Width x Height, mm)	172x203	227x233	220x234	145.5x178	145.5x178	145.5x209	191x228	90x325
Mass (kg)	3.4	6.5	12	4.3	4.5	6.3	8.5	10.5

● 2D Nozzles *For additional specifications and information, contact our local sales.

Type	TD-201	TD-211	TDH-211	HS-20	HS-22	HS-23	HS-25	HS-322
Liquid pressure range (MPa)	0.2-8.0	0.2-8.0	4.0-20.0	0.5-2.0	4.0-20.0	4.0-35.0	35.0-50.0	4.0-20.0
Maximum use temperature (deg C)	80	80	120	120	120	120	120	120
Maximum spray capacity (ℓ/min)	150	300	700	60	150	300	300	300
Pipe connection size	PT3/4"	PT1"	PT1"	PT3/4"	PT1/2"	PT3/4"	PT3/4"	PT1/2"
Dimensions (Width x Height, mm)	122x203	141x233	141x234	101x178	101x178	101x209	138x228	145.5x178
Mass (kg)	3	5.5	8	3.6	3.8	5.1	7	4.6

Conversion of unit [Pressure] 0.1MPa ≒ 14.50psi [Flow rate] 1ℓ (liter) ≒ 0.264 US gal.
10psi ≒ 0.069MPa 1US gal. ≒ 3.79ℓ (liter)

ES series Rotating Cleaning Nozzles for Tanks/Containers (Low pressure type)

Surface finish ● Cleaning for chemical tanks

Stainless steel type



PTFE type



FEATURES

Easy to disassemble and clean the components due to low number of parts.

Complete, uniform cleaning by rotating flat spray pattern. (stainless steel type)

[Spray variations]

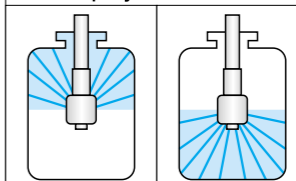

180° upward spray 180° downward spray

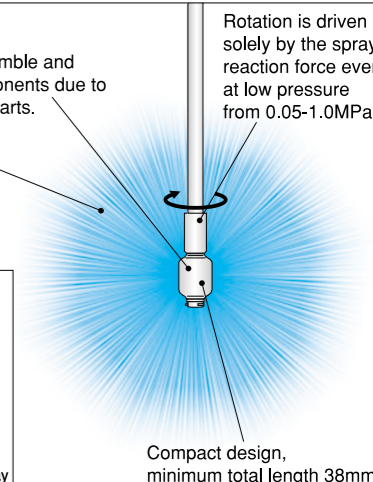

Stainless steel type

Spray Capacity Code	Pipe Conn. Size	Spray Capacity at 0.3MPa (ℓ/min)	Dimensions (mm)	Mass (g)	Spray Pattern
01	1/8F	7	φ16x38	20	360° 180° upward 180° downward
02	1/8F	13	φ20x53	35	
03	1/4F	20	φ25x65	75	
05	3/8F	31	φ30x97	155	
1	3/8F	42	φ31.5x115	185	
2	1/2F	70	φ41.5x123	260	
3	3/4F	150	φ60x139	605	
4	1F	210	φ75x163	925	
5	1 1/2F	440	φ88x180	1640	

PTFE type

Spray Capacity Code	Pipe Conn. Size	Spray Capacity at 0.3MPa (ℓ/min)	Dimensions (mm)	Mass (g)	Spray Pattern
30	1/2F	30	φ50x65	130	360° 180° upward 180° downward
40		40			
70	3/4F	70	φ57x75	180	
150		150			

*Max. allowable temperature for ES series, PTFE type is 93°C.

*Max. allowable temperature for ES series, stainless steel type is 60°C.

Affiliated Products N-series Rotating Tank Cleaning Nozzle (Low-Medium pressure)

Clean Nozzle N-7



Clean Nozzle NB-0S



Clean Nozzle NB-2RP



SHOWER BALL



Series	Clean Nozzle N-7	Clean Nozzle NB-0S	Clean Nozzle NB-2RP	SHOWER BALL
Pressure (MPa)	0.3-0.8	0.3-0.7	0.5-1.0	0.1-0.5
Reach distance (m)	About 2-8	About 1.5-3	About 5-8.5	About 2-5
Principal material	S304 PTFE or others	S304 PTFE	S304 PTFE	S304, S316 PTFE, PP, PE
Pipe Conn. size	1 1/2F	3/4F	2F	—
Dimensions	102x150x163	φ50x130	φ130x250	φ60, φ80, φ100
Mass (kg)	4	0.45	2.1	0.15 or more

*Max. allowable temperature for N-series is 60°C.

For details, please refer to our special leaflets.

CLJ series COOLJetter® Cooling Fan Unit with Semi Dry Fog® Nozzles

All process

- Air cooling in working area to improve work environment
- Spot cooling of heated refractories and steel products
- Dust suppression
- Spraying of deodorizer

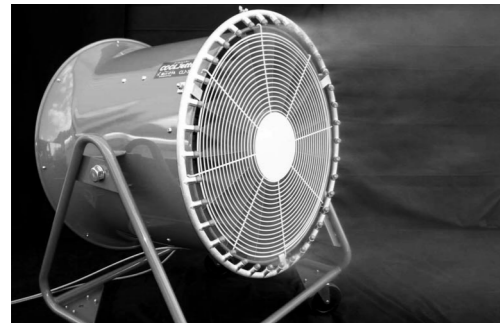

FEATURES

Energy-economizing unit cools outdoor and semi-enclosed spaces at low cost. Equipped with LYOHM nozzles spraying 10-30μm Semi Dry Fog®.

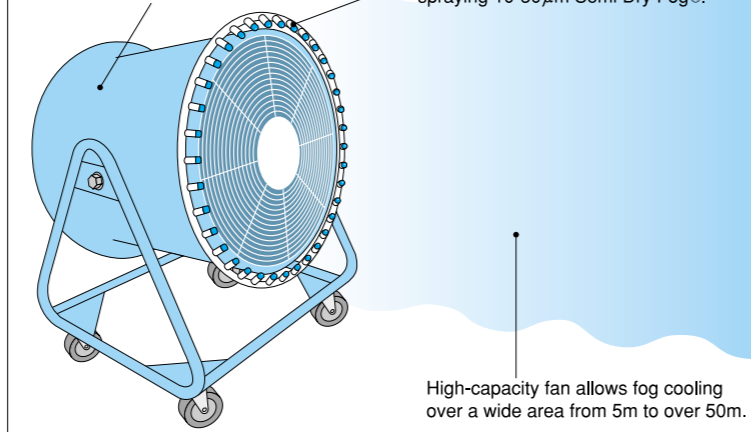

High-capacity fan allows fog cooling over a wide area from 5m to over 50m.

Product code	Dimensions			Nozzle Quantity (pcs.)	Spray capacity (ℓ/hr)		Fan ventilation (m³/min) (50/60Hz)	Power supply Power consumption	Noise level (dB) (50/60Hz)	Remarks
	Fan diameter (mm)	W x D x H (mm)	Mass (kg)		3MPa	6MPa				
CLJ-300	φ300	420x480x800	10	8	13.6	18.8	79/87	AC100V 80W	48/51	Optional *3 60-degree oscillation
CLJ-370	φ370	642x468x736	26	12	20.4	28.2	75/90	AC100V 440W (50Hz) 580W (60Hz)	66/70	•With casters •Elevation angle can be adjusted up to 35°.
CLJ-590D *2	φ590	830x545x975	76	36	61.2	86	320	AC200V (Three-phase) 1500W	77	•With casters •Elevation angle can be adjusted up to 90°. •IP55 compliant Optional *3 90-degree oscillation

● Pump unit (sold separately) is required for use. (*1) Noise level is the mean value of those measured at 1.5m behind and both sides of the fan.
(*2) Adding the 90-degree oscillation option to the CLJ-590D base makes product code CLJ-590, which is IP44 compliant.
(*3) For CLJ-300 and CLJ-590D, shape of the fan base (foot) differs with or without optional features.

Pump Unit



Product code	Dimensions		Max. pressure (MPa)	Max. capacity (ℓ/hr)	Power supply (voltage) Power consumption (50/60Hz)	Includes	
	W x D x H (mm)	Mass (kg)					
KRT20-051K (with filter)	340x650x425	32.5	6.0	36/42 (50/60Hz)	AC100V 320/380W	•Pressure gauge •Water tank with ball tap (approx. 2ℓ) •Water filter (5μm) •Casters	
KRT20-11K (with filter)				48/66 (50/60Hz)	AC100V 370/420W		
KRT40-21K (with filter)				102/126 (50/60Hz)	AC100V 410/460W		
TKP75A-41K (with filter)	390x740x625	61		210/258 (50/60Hz)	AC100V 850/950W		•Pressure gauge •Water tank with ball tap (approx. 7~11ℓ) •Water filter (5μm) •Casters
KYZ150-91K (with filter)				438/528 (50/60Hz)	AC200V/AC200~220V (3φ) 1700/1900W		
KYZ220-131K (with filter)	400x680x550	65		654/786 (50/60Hz)	AC200V/AC200~220V (3φ) 2400/2600W		

*KYZ150-91K and KYZ220-131K are made-to-order products.

Examples of COOLJetter® applications

Cooling in factories



Dust suppression



Affiliated Products

Portable cart type CLJ-C300A



- Easily portable cart type with compact pump (Max. pressure 1MPa) and tank (50ℓ).
- Low power consumption, only 140W! Energy-saving Cooling.
- High-capacity fan allows cooling at a distance of 15m.
- Oscillation, with water level sensor.
- With special cooling nozzle "LYOHM" x6pcs.

Electric fan type CLJ-S-B

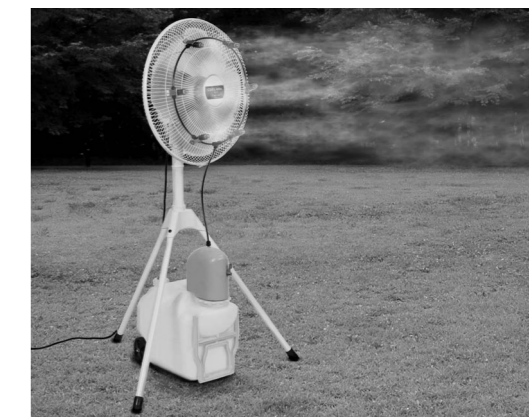

- With compact pump (Max. pressure 1MPa) and tank (20ℓ).
- Variable air volume in 3 levels.
- If your factory has a fan, you can order only the spraying unit.
- With special cooling nozzle "LYOHM" x6pcs.

Please contact our local sales for details.

Eco-friendly fog technology

Fog technology, used for cooling in the production of high quality steel, is also important to improve the Earth's environment, to combat global warming and control dust problems.

Fog cooling equipment can provide effective cooling in places where air conditioners are not practical (such as outdoors) and make you feel cool and comfortable like after a rain shower. It also clears dust from the air as does the sprinkling of water.

ARS Filter Auto Reverse Self-cleaning Filter

Patent pending

- All process**
- Recycling of drainage water after cleaning
 - Industrial water filtration, cooling water filtration

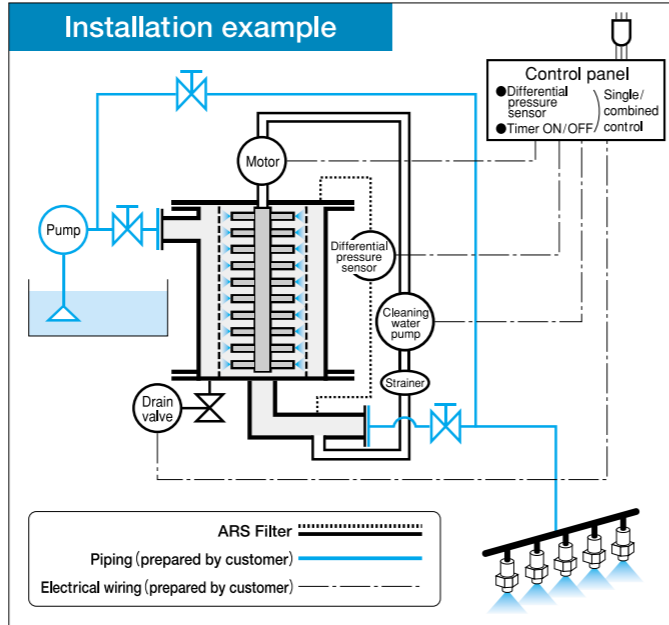
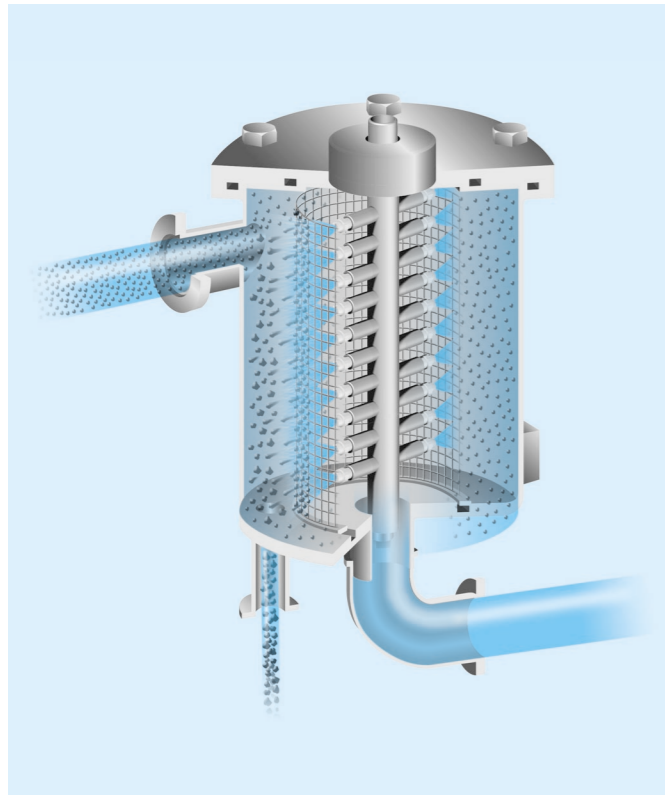

- ARS Filter employs a high-pressure jet spray backwashing method. It ensures stable cleaning, without requiring consumable parts such as cleaning brushes.
- Compact design to install in a small space.
- Detecting the pressure difference caused by an accumulation of foreign particles on the filter, ARS starts jet spray cleaning automatically and discharges foreign particles through the drain.
- You can keep using filtrated water while cleaning the filter screen.

SPECIFICATIONS

Model No.	ARS-500	ARS-1000	ARS-2500
Maximum flow rate (ℓ/min)	500	1000	2500
Screen mesh size (μm)	Metal wire screen	100~500	
	Wedge wire screen		

ARS Filter used in recycling of industrial water for cooling steel plates

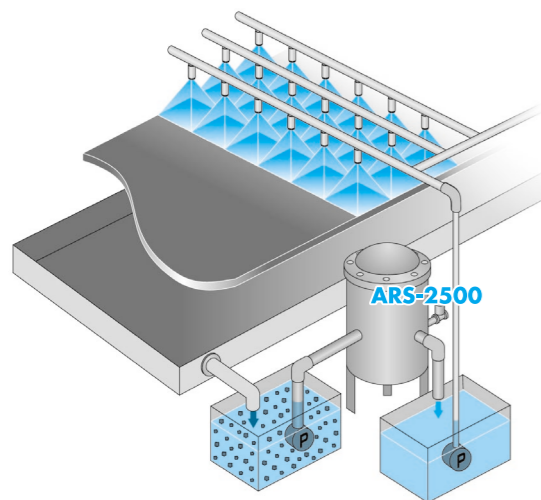

Nozzles became clogged due to foreign particles in the industrial water.

↓ After ARS Filter is installed...

Stable production and stable operation

- Liquid: Industrial water
- Foreign particles: Algae, sand, etc.
- Self-cleaning system: Backwashing while filtering continues
- Screen mesh size: 100, 300 μm
- Type of screen: Wedge wire

For details, please refer to our catalog of ARS Filter (Auto Reverse Self-cleaning Filter).

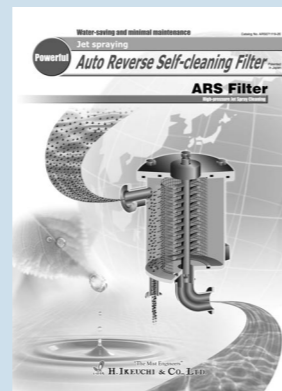

Spray Nozzles Lineup for Cast Steel Cooling

Series	DOVEA	DOVEA-W	DDA	DDRP+AS	VVP	VVP+AS
Pneumatic or hydraulic	Pneumatic	Pneumatic	Pneumatic	Hydraulic/Pneumatic (dual-use)	Hydraulic	Hydraulic/Pneumatic (dual-use)
Spray pattern/distribution	Flat spray Even distribution	Thick flat spray Even distribution	Oval spray Even distribution	Extra-thick flat spray Even distribution	Flat spray Mountain-shaped distribution	Flat spray Mountain-shaped distribution
Spray pattern image						
Spray distribution image (widthwise)						
Spray angle (°) (thickness)	15~35	30~40	15~45	60	(5)	(5)
Turndown ratio*1	1 : 30	1 : 20	1 : 10	1 : 20	1 : 2	1 : 20
Page of this catalog	P.15~16	P.16	P.17~18	P.19~20	P.31~32	P.33

Series	WVVP	WVVEP	EJVV	DDRP	LLYOH
Pneumatic or hydraulic	Hydraulic	Hydraulic	Hydraulic	Hydraulic	Hydraulic
Spray pattern/distribution	Thick flat spray Mountain-shaped distribution	Thick flat spray Even distribution	Thick flat spray Even distribution	Extra-thick oval spray Even distribution	Hollow cone spray header
Spray pattern image					Put the hollow cone nozzles in alignment
Spray distribution image (widthwise)					
Spray angle (°) (thickness)	15~25	15~30	20~25	45~60	—
Turndown ratio*1	1 : 2	1 : 2	1 : 2	1 : 3	—
Page of this catalog	P.34	P.35	P.36	P.37	P.52

*1) Turndown ratio is the ratio between adjustable minimum spray capacity and maximum spray capacity.

Profile of Supporting Data

To aid in cooling nozzle selection, IKEUCHI can perform a variety of measurements and simulations.

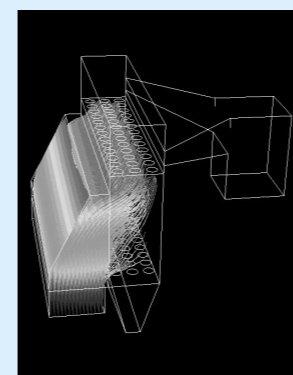

Thermo-fluid analysis data



Droplet diameter and speed reference charts

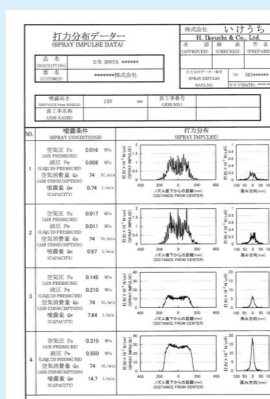

Impact force distributions across width and thickness (for single unit)

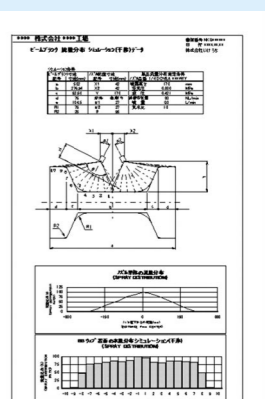

Simulation of flow rate distribution at surface of a beam blank